



**A universal transmitter
compatible with all
Honeywell Analytics gas
sensor technologies**

XNX Universal Transmitter



Flexible

- Compatible with all Honeywell Analytics gas sensors
- Allows selection of best sensor technology for each application
- Choice of all industry standard output signals
- Ability to adapt configuration as site needs change
- Future-proofed for any new output standards

Common Transmitter Platform

- Simplified and reduced cost of installation
- Reduced training time and cost
- Less chance of misinterpreting messages
- Less chance of incorrectly changing settings
- Reduced maintenance, spares, stock and cost

Global Approvals

- European, US and Canadian
- Compliant with ATEX, UL and CSA standards
- ATEX, UL and CSA performance approval
- IEC61508 SIL 2

Easy to Use

- Easy read multilingual backlit LCD with text, bar graph, digits and icons
- Local or remote sensor mounting options
- Selectable sink, source or isolated 4-20mA output to suit preferred wiring topology
- HART® communications as standard for remote diagnostics/configuration

Reduced Operational Costs

- Fully configurable via non-intrusive magnetic switches
- No hot work permit needed
- Hot swap toxic and Oxygen sensor cartridges
- Serviceable catalytic and IR sensors
- Auto-inhibit during maintenance

Friendly Installation

- Integral surface mounting lugs or optional pipe or ceiling mounting brackets
- 5 x M25 or ¾" NPT cable/conduit/sensor entries
- Plug-in 'POD' module removes to give access to terminal area
- Removable plug/socket type terminal blocks for ease of wiring

Typical Applications

- Offshore oil and production platforms
- Oil and gas exploration and drilling
- Refineries
- Chemical and petrochemical plants
- Onshore oil and gas terminals
- Gas transmission
- Power stations

XNX is an extremely flexible transmitter that can be configured to accept an input from any of the Honeywell Analytics range of gas sensor technologies. It can also be configured to provide a wide variety of industry standard output signals. This enables users to have a single type of interface to all their gas detection needs, even when different types of detectors are employed, to most effectively address the different gas detection applications on site.



The most effective gas detection systems often employ a variety of detection technologies including point flammable detectors (both catalytic and infrared type), toxic and Oxygen electrochemical cell type detectors and open path infrared detectors. XNX provides a common transmitter interface to all of these and can be configured to provide industry standard signal outputs to match the individual requirement of each application or the preferred site standard. If site output standards change, XNX can be reconfigured to provide the new required output. XNX has also been future-proofed by having the ability to have other output modules fitted as new output standards are developed and adopted by industry.

Having a common transmitter platform for all your gas detectors brings further benefits. Common tools and installation methods simplifies and reduces cost of installation. The common user interface makes operation faster to learn and easier to navigate, thus reducing time needed for training as well as reducing the chance of incorrectly interpreting messages or incorrectly changing settings. Common spare parts also mean reduced maintenance spares stock levels and cost for all detectors.

XNX allows you to apply the most appropriate gas detection technologies for each application, standardise the interface to those detectors and has the flexibility to provide the required signal outputs. With XNX the answer is always yes.

XNX Universal Transmitter

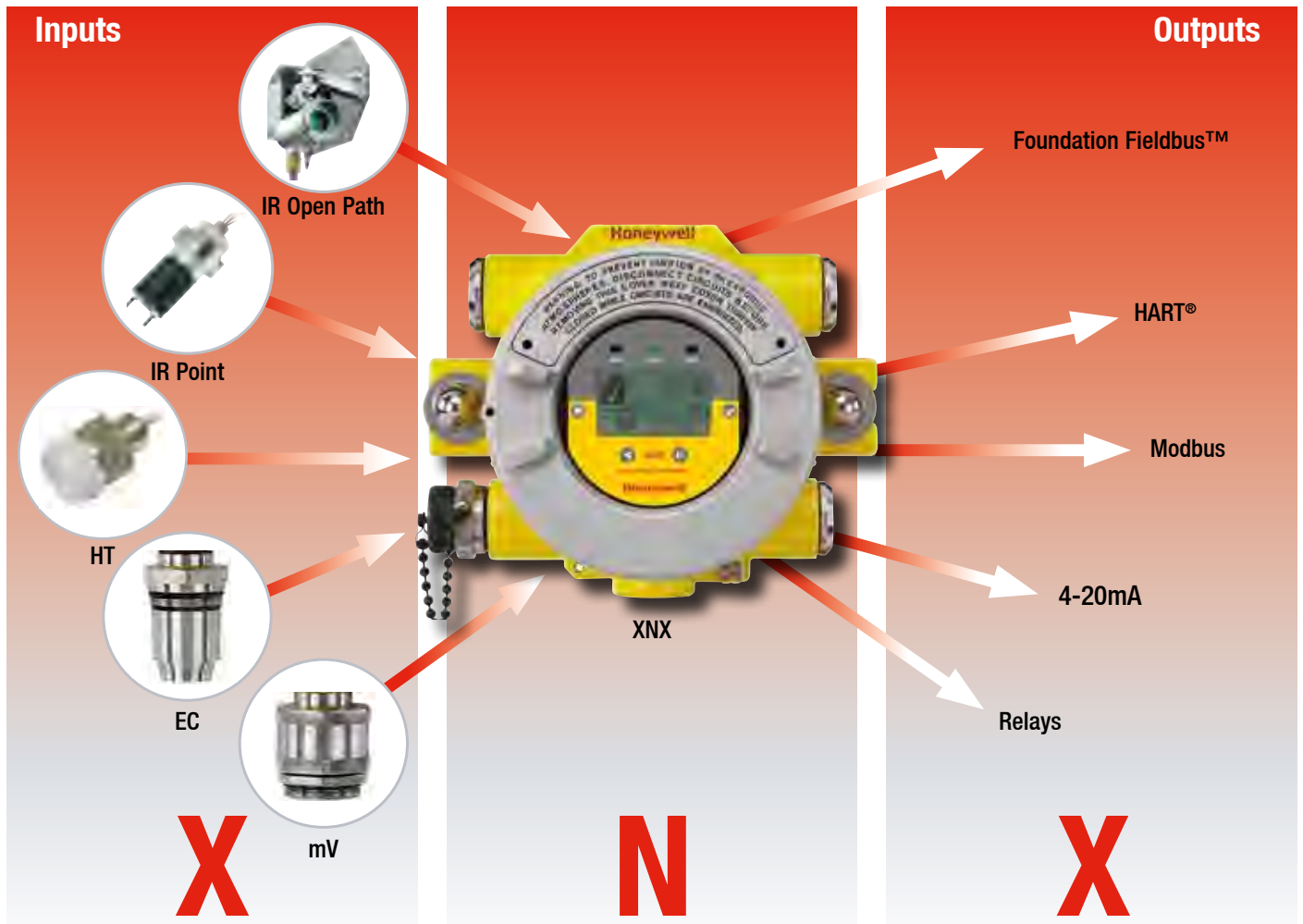

XNX Transmitter

XNX has Worldwide hazardous area and performance approvals and is housed in a flameproof enclosure that is available in either painted marine grade aluminum alloy or stainless steel 316 versions. A large backlit multilingual LCD clearly indicates the unit's status using a combination of text, digits and icons. Users can modify its operation using the LCD and magnet switches without ever needing to open the unit. An optional local IS HART® terminal port is also available. Both enable one man, non-intrusive, operation and reduce routine maintenance time and costs. Local LEDs are also provided to indicate the unit's status at a glance.

XNX Transmitter Sensor Compatibility

XNX is compatible with all of the Honeywell Analytics range of industrial fixed gas sensors including Searchline Excel, Searchpoint Optima Plus, Sensepoint (HT and PPM) and Model 705. For further information on these sensors, please refer to their individual datasheets.



XNX with Searchpoint Optima Plus



XNX MPD Sensor



XNX EC Sensor

The Multi Purpose Detector (MPD) is a serviceable stainless steel sensor housing with plug-in catalytic and infrared sensor cartridges. The catalytic sensors measure flammable gases in the range 0-100%LEL and the infrared sensors measure Hydrocarbons in the range 0-100%LEL, or Methane 0-100%LEL (or 0-5%Vol) and CO₂ 0-5%Vol. See the specifications section for full details of the MPD sensor.

The XNX EC sensor is also a serviceable stainless steel sensor with a wide range of toxic and Oxygen plug-in sensor cartridges. The XNX EC sensor interface to the XNX transmitter is intrinsically safe, allowing the sensors to be 'hot swapped' without the need for a hot work permit. This reduces the cost of ownership by reducing the cost and time to service the detector.

XNX Universal Transmitter

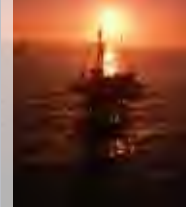

XNX Transmitter Configuration

XNX has three basic personalities (configurations) which support different types of sensor. The personality boards and optional output interfaces are enclosed in the electronics POD (Personality, Options and Display). The POD determines the XNX transmitter behaviour based on the sensor type attached to it and the selected output options.

The mV (millivolt) personality is used for all mV signal input sensors including MPD, Sensepoint HT, PPM and the Model 705. The EC (Electrochemical cell) personality is for use with the XNX EC toxic and Oxygen sensors. The IR (infrared) personality is for use with the Searchline Excel open path and Searchpoint Optima Plus point infrared gas detectors.

The table below shows the three basic XNX transmitter configurations and the sensors each supports.

XNX Transmitter Main Components

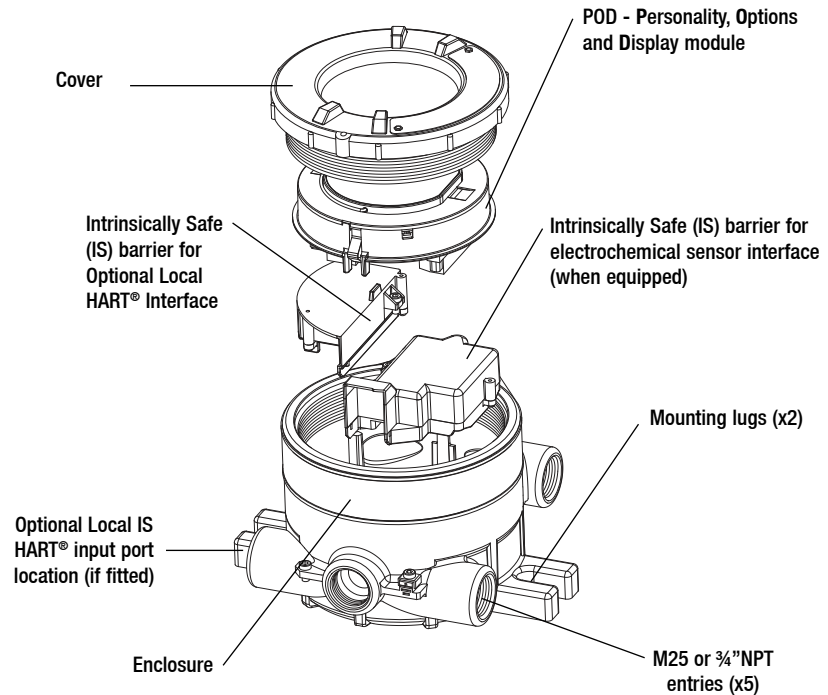

Personality	XNX mV					XNX EC	XNX IR	
Sensors Supported	MPD Flammable Catalytic	MPD Flammable Infrared (Flam and CO ₂)	Sensepoint HT (High Temperature)	Sensepoint PPM	Model 705 HT (High Temperature)	XNX Toxic and Oxygen Sensors	Searchpoint Optima Plus	Searchline Excel
Product Image								

Mechanical Installation Options

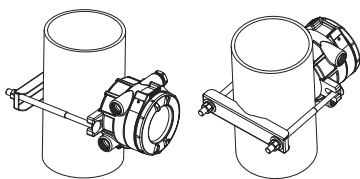

Vertical or Horizontal Pipe Mounted (Using Optional Pipe Mounting Bracket)

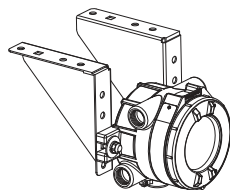

Ceiling Mount

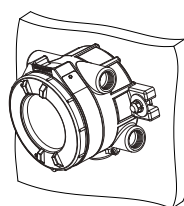

Surface Mounted

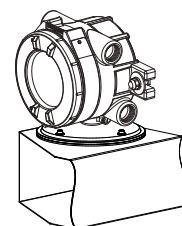

Duct Mounted

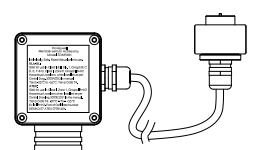

Optional remote sensor mounting kit for XNX EC sensor

Honeywell Analytics Gas Detection



Honeywell Analytics is able to provide gas detection solutions to meet the requirements of all applications and industries. Contact us in the following ways:

Headquarters

Europe, Middle East, Africa

Life Safety Distribution AG

Javastrasse 2

8604 Hegnau

Switzerland

Tel: +41 (0)44 943 4300

Fax: +41 (0)44 943 4398

gasdetection@honeywell.com

Customer Service:

Tel: 00800 333 222 44 (Freephone number)

Tel: +41 44 943 4380 (Alternative number)

Fax: 00800 333 222 55

Middle East Tel: +971 4 450 5800 (Fixed Gas Detection)

Middle East Tel: +971 4 450 5852 (Portable Gas Detection)

Americas

Honeywell Analytics Distribution Inc.

405 Barclay Blvd.

Lincolnshire, IL 60069

USA

Tel: +1 847 955 8200

Toll free: +1 800 538 0363

Fax: +1 847 955 8210

detectgas@honeywell.com

Asia Pacific

Honeywell Analytics

Asia Pacific

#701 Kolon Science Valley (1)

43 Digital-Ro 34-Gil, Guro-Gu

Seoul 152-729

Korea

Tel: +82 (0) 2 6909 0300

Fax: +82 (0) 2 2025 0328

India Tel: +91 124 4752700

analytics.ap@honeywell.com

Technical Support Centres

Honeywell Analytics Ltd.

4 Stinsford Road

Nuffield Industrial Estate

Poole, Dorset, BH17 0RZ

United Kingdom

Tel: +44 (0) 1202 645 544

Fax: +44 (0) 1202 645 555

Honeywell Analytics

ZAC Athélia 4 - 375 avenue du Mistral

Bât B, Espace Mistral

13600 La Ciotat

France

Tel: +33 (0) 4 42 98 17 75

Fax: +33 (0) 4 42 71 97 05

Honeywell Analytics

Elsenheimerstrasse 43

80687 München

Germany

Tel: +49 89 791 92 20

Fax: +49 89 791 92 43

Honeywell Analytics

P.O. Box-45595

6th Street

Musaffah Industrial Area

Abu Dhabi

UAE

Tel: +971 2 554 6672

Fax: +971 2 554 6672

EMEA: HAexpert@honeywell.com

US: ha.us.service@honeywell.com

AP: ha.ap.service@honeywell.com

www.honeywellanalytics.com

www.raesystems.com

Honeywell Analytics
Experts in Gas Detection

Please Note:

While every effort has been made to ensure accuracy in this publication, no responsibility can be accepted for errors or omissions. Data may change, as well as legislation, and you are strongly advised to obtain copies of the most recently issued regulations, standards, and guidelines. This publication is not intended to form the basis of a contract.

12550_H_XNX_DS01078_V5_EMEA

09/15

© 2015 Honeywell Analytics



K. D. Fisher & Co. Pty Ltd ABN 27 007 879 647
Head office 18 Benjamin Street St Marys SA 5042
T +61 8 8277 3288 T 1300 533 474
E kdf@kdfisher.com.au kdfisher.com.au



Honeywell